

File 2 Recessed 32W/m

code F2038.940XD/01

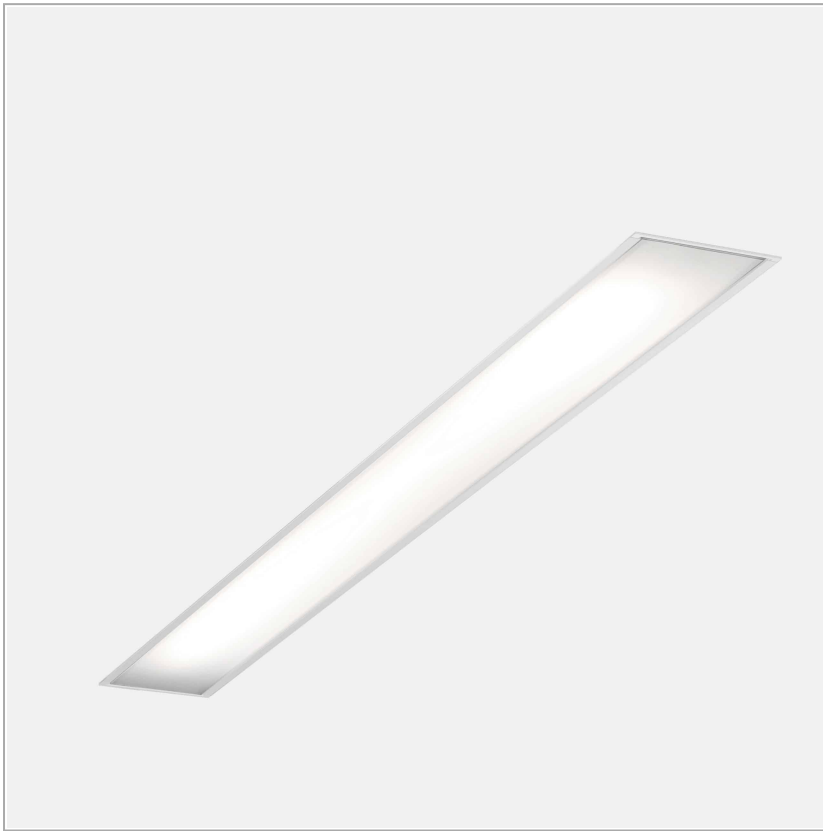

PRODUCT DESCRIPTION

Indoor recessed direct light lamp made of extruded aluminium 6060, complete with LED; colour rendering index CRI >90. Professional led modules 90 W 4000°K assembled and wired on extruded aluminium heat sink with high performance reflector, equipped with harmonic steel springs for installation in Tools free profile; protocol Dimmable Dali. Lamp with white colour finish; made of polycarbonate with diffusing film. Protection class IP40/IP43.

PRODUCT SPECS

Installation method	Recessed with frame
Light source	linear LED 32W/mt CRI90
Absorbed power	90 W
Color temperature	4000K
Color rendering index CRI	90
Optic	Microprismatic diffuser
Finishing	White
Luminous flux of the product	7408 lm
Luminous efficiency	82 lm/W
Protocol	Dimmable Dali
Energy efficiency class	D
Dimension	L2825 mm
Hole size	80xL+2 mm
IP Grade	Inst. Parete Ip40 / Inst. Soffitto Ip43
Power supply	220-240V 50-60Hz

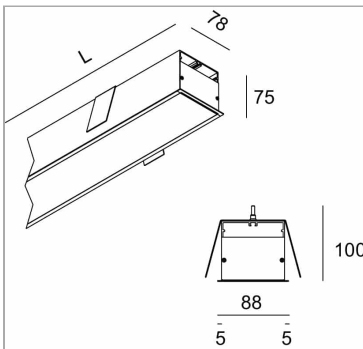

FILE2 microprismatic LED

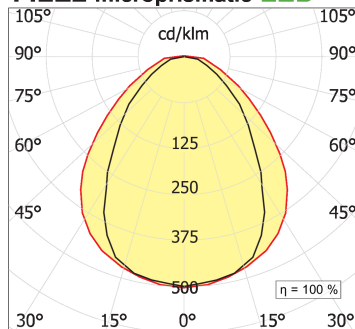

WEB PAGE



ASSEMBLY INSTRUCTIONS



OPTIONAL ACCESSORIES

Container File 2 Empty profile

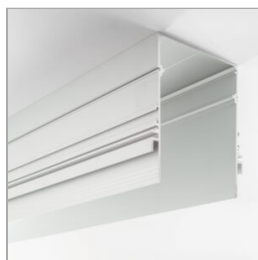

code LTF2.1000/01

Trimless, fully-retracting flush recessed modular systems for housing system profiles and MINIFILE, FILE, FILE 2, FILE 2 COMPLEMENTI, LEVA and FARETÈN finished modules for creating cuts of continuous light or where light modules alternate to voids, in plaster-board false-ceiling or false-walls or in concrete or brick walls. Painted or anodised extruded aluminium body, with a predefined length or cut to size. To be completed with side end caps and finishing cover for the empty spaces in a retracted position to determine an effect of solids and voids. Can also be used with LED linear light sources, to be completed with opal white PC diffusing screen and remote power supplies, to create retracted grooves of light.

Technical Sheet

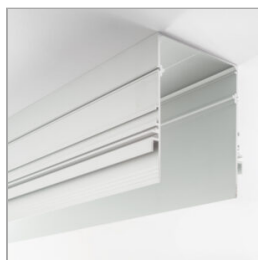

code LTF2.2000/01

Trimless, fully-retracting flush recessed modular systems for housing system profiles and MINIFILE, FILE, FILE 2, FILE 2 COMPLEMENTI, LEVA and FARETÈN finished modules for creating cuts of continuous light or where light modules alternate to voids, in plaster-board false-ceiling or false-walls or in concrete or brick walls. Painted or anodised extruded aluminium body, with a predefined length or cut to size. To be completed with side end caps and finishing cover for the empty spaces in a retracted position to determine an effect of solids and voids. Can also be used with LED linear light sources, to be completed with opal white PC diffusing screen and remote power supplies, to create retracted grooves of light.

Technical Sheet

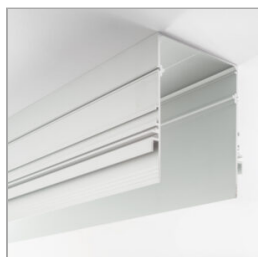

code LTF2.3000/01

Trimless, fully-retracting flush recessed modular systems for housing system profiles and MINIFILE, FILE, FILE 2, FILE 2 COMPLEMENTI, LEVA and FARETÈN finished modules for creating cuts of continuous light or where light modules alternate to voids, in plaster-board false-ceiling or false-walls or in concrete or brick walls. Painted or anodised extruded aluminium body, with a predefined length or cut to size. To be completed with side end caps and finishing cover for the empty spaces in a retracted position to determine an effect of solids and voids. Can also be used with LED linear light sources, to be completed with opal white PC diffusing screen and remote power supplies, to create retracted grooves of light.

Technical Sheet

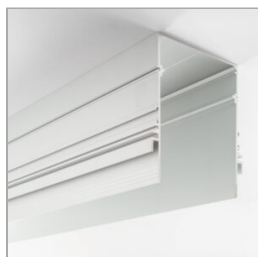

code LTF2.misura/01

Trimless, fully-retracting flush recessed modular systems for housing system profiles and MINIFILE, FILE, FILE 2, FILE 2 COMPLEMENTI, LEVA and FARETÈN finished modules for creating cuts of continuous light or where light modules alternate to voids, in plaster-board false-ceiling or false-walls or in concrete or brick walls. Painted or anodised extruded aluminium body, with a predefined length or cut to size. To be completed with side end caps and finishing cover for the empty spaces in a retracted position to determine an effect of solids and voids. Can also be used with LED linear light sources, to be completed with opal white PC diffusing screen and remote power supplies, to create retracted grooves of light.

Technical Sheet



Couple of closure heads 78 mm

code LT2890.1

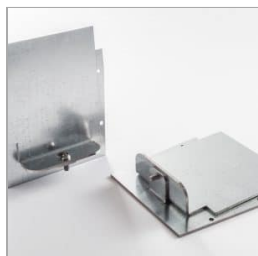

Modular system for direct, diffused and/or accent lighting, consisting of hollow profiles made from 75x78 mm painted or anodised extruded aluminium, with a predefined length or cut to measure, available in the following versions: wall-mounted, ceiling-mounted, suspended, recessed with a super-slim edge trim, just 5 mm wide, and trimless, fully-retracting flush recessed. To be integrated with LED linear light sources, battens for T16 and T16 seamless fluorescent lamps, recessed versions with built-in LED source or for QPAR16 halogen/LED lamps and max 16A 3-circuit track modules for inclusion of projectors. Fluorescent battens, complete with 50/60 Hz 230/240 V electronic power supply, LED batten driver included. To be completed with side end caps with Light Proof system, opal white or microprismatic PC diffusing screen (in accordance with EN 12464-1), closing profiles, with a predefined length or cut to measure, or darklight aluminium grille with high specular qualities and mounting brackets or suspension cables. IP20/IP40 protection rating.

Technical Sheet



File 2 System Single bracket to fix the lighting modules

Complies with EN605981 and related notes. In the absence of metric symbols, the measurements are all in millimetres.

Luminous flux and power data are initially subject to tolerances +/- 10%. The values refer to an ambient temperature of 25°C unless otherwise specified. We reserve the right to make changes to our products at any time.

Page 2 / 3

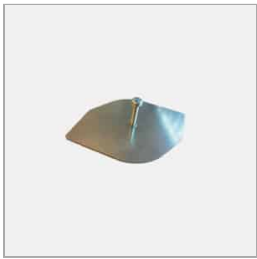

code LT2891

order 2 Brackets For proFile

Technical Sheet

