

Mini Track Biemission Module 24/48V

code LT9402/01

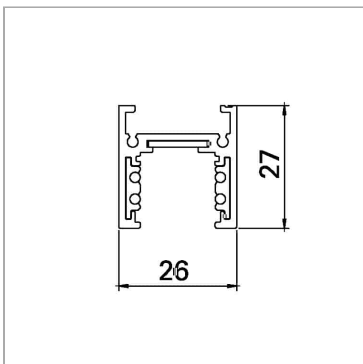
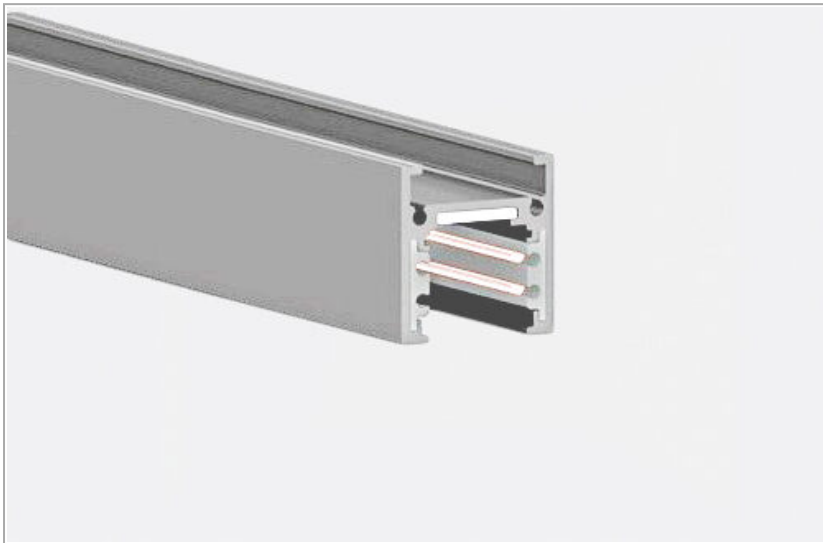

PRODUCT DESCRIPTION

The Mini Track track is an electrified Class III-SELV track with two circuits: one for a low voltage 24/48V power supply and the other for the DATA BUS (DALI or 1-10V). The power supply voltage can be 24V or 48V, not exceeding 15°, depending on the models of lighting fixtures chosen. White and black finishes are available in the ceiling and suspended versions, while only the black finishing for the recessed option. The lighting fixtures can be used on both 24V or 48V electrified tracks, except the microfile family that requires only 24V. DALI dimmable spotlights are equipped with non-polarized converters that allow to be installed in any direction, and Hot Plug technology for safe insertion with live track.

PRODUCT SPECS

Installation method	Suspension
Finishing	White
Dimension	L2000xW26xH27 mm
Power supply/Transformer	Not included
Protocol	See power supply

WEB PAGE



ASSEMBLY INSTRUCTIONS



MANDATORY ACCESSORIES

Biemission track blind end



code LT9410/01

The Mini Track track is an electrified Class III-SELV track with two circuits: one for a low voltage 24/48V power supply and the other for the DATA BUS (DALI or 1-10V). The power supply voltage can be 24V or 48V, not exceeding 15°, depending on the models of lighting fixtures chosen. White and black finishes are available in the ceiling and suspended versions, while only the black finishing for the recessed option. The lighting fixtures can be used on both 24V or 48V electrified tracks, except the microfile family that requires only 24V. DALI dimmable spotlights are equipped with non-polarized converters that allow to be installed in any direction, and Hot Plug technology for safe insertion with live track.

Technical Sheet



OPTIONAL ACCESSORIES

Mini Track – Indirect opal white polycarbonate diffuser



code LT94P.1000

The Mini Track track is an electrified Class III-SELV track with two circuits: one for a low voltage 24/48V power supply and the other for the DATA BUS (DALI or 1-10V). The power supply voltage can be 24V or 48V, not exceeding 15°, depending on the models of lighting fixtures chosen. White and black finishes are available in the ceiling and suspended versions, while only the black finishing for the recessed option. The lighting fixtures can be used on both 24V or 48V electrified tracks, except the microfile family that requires only 24V. DALI dimmable spotlights are equipped with non-polarized converters that allow to be installed in any direction, and Hot Plug technology for safe insertion with live track.

Technical Sheet



code LT94P.2000

The Mini Track track is an electrified Class III-SELV track with two circuits: one for a low voltage 24/48V power supply and the other for the DATA BUS (DALI or 1-10V). The power supply voltage can be 24V or 48V, not exceeding 15°, depending on the models of lighting fixtures chosen. White and black finishes are available in the ceiling and suspended versions, while only the black finishing for the recessed option. The lighting fixtures can be used on both 24V or 48V electrified tracks, except the microfile family that requires only 24V. DALI dimmable spotlights are equipped with non-polarized converters that allow to be installed in any direction, and Hot Plug technology for safe insertion with live track.

Technical Sheet



code LT94P.3000

The Mini Track track is an electrified Class III-SELV track with two circuits: one for a low voltage 24/48V power supply and the other for the DATA BUS (DALI or 1-10V). The power supply voltage can be 24V or 48V, not exceeding 15°, depending on the models of lighting fixtures chosen. White and black finishes are available in the ceiling and suspended versions, while only the black finishing for the recessed option. The lighting fixtures can be used on both 24V or 48V electrified tracks, except the microfile family that requires only 24V. DALI dimmable spotlights are equipped with non-polarized converters that allow to be installed in any direction, and Hot Plug technology for safe insertion with live track.

Technical Sheet



Mini Track Biemission Module 90° joint

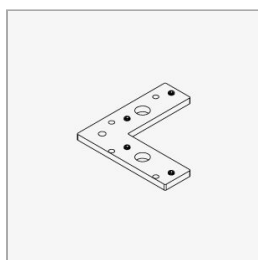

code LT9346

The Mini Track track is an electrified Class III-SELV track with two circuits: one for a low voltage 24/48V power supply and the other for the DATA BUS (DALI or 1-10V). The power supply voltage can be 24V or 48V, not exceeding 15°, depending on the models of lighting fixtures chosen. White and black finishes are available in the ceiling and suspended versions, while only the black finishing for the recessed option. The lighting fixtures can be used on both 24V or 48V electrified tracks, except the microfile family that requires only 24V. DALI dimmable spotlights are equipped with non-polarized converters that allow to be installed in any direction, and Hot Plug technology for safe insertion with live track.

Technical Sheet



suspension hanger



code LT9411

The Mini Track track is an electrified Class III-SELV track with two circuits: one for a low voltage 24/48V power supply and the other for the DATA BUS (DALI or 1-10V). The power supply voltage can be 24V or 48V, not exceeding 15°, depending on the models of lighting fixtures chosen. White and black finishes are available in the ceiling and suspended versions, while only the black finishing for the recessed option. The lighting fixtures can be used on both 24V or 48V electrified tracks, except the microfile family that requires only 24V. DALI dimmable spotlights are equipped with non-polarized converters that allow to be installed in any direction, and Hot Plug technology for safe insertion with live track.

Technical Sheet



Tracks System Steel suspension cable

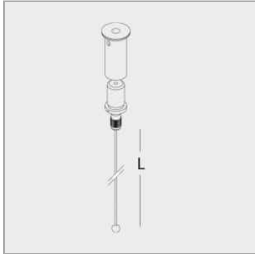

code LT9036.1

The Mini Track track is an electrified Class III-SELV track with two circuits: one for a low voltage 24/48V power supply and the other for the DATA BUS (DALI or 1-10V). The power supply voltage can be 24V or 48V, not exceeding 15°, depending on the models of lighting fixtures chosen. White and black finishes are available in the ceiling and suspended versions, while only the black finishing for the recessed option. The lighting fixtures can be used on both 24V or 48V electrified tracks, except the microfile family that requires only 24V. DALI dimmable spotlights are equipped with non-polarized converters that allow to be installed in any direction, and Hot Plug technology for safe insertion with live track.

Technical Sheet



Private: Tracks System Bending tool

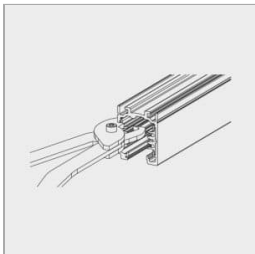

code LT9043.1

3 phase mixed-system electrified track, with two additional conductors to manage a general digital or analogic signal (1-10V, DALI, dmx, lon, eib, etc.). Body made of powder coated extruded aluminum, housing four copper conductors (three phases and one neutral 16A) and two copper conductors for the data signal, insulated in PVC. 4mm²-section earth conductor incorporated in the extrusion. Arranged for ON/OFF separate three-circuit switch or management through digital signal (DALI). EN 60570 certified. Its installation must be accomplished by highly qualified personnel. Four possible installation systems: directly on ceiling/wall by using the needlepoints provided on the track, on ceiling/wall by using the metal clips (order separately), hanging by using the suspension kits (order separately) or recessed, without exceeding the maximum loads. To be used with projectors provided with Eurostandard adapter (for standard use) or with DALI-Stucchi adapter (for DALI use).

Technical Sheet



Private: Mini Track Biemission Module Integrated bluetooth bridge



code LT9120BD/01

The Mini Track track is an electrified Class III-SELV track with two circuits: one for a low voltage 24/48V power supply and the other for the DATA BUS (DALI or 1-10V). The power supply voltage can be 24V or 48V, not exceeding 15°, depending on the models of lighting fixtures chosen. White and black finishes are available in the ceiling and suspended versions, while only the black finishing for the recessed option. The lighting fixtures can be used on both 24V or 48V electrified tracks, except the microfile family that requires only 24V. DALI dimmable spotlights are equipped with non-polarized converters that allow to be installed in any direction, and Hot Plug technology for safe insertion with live track.

Technical Sheet



Mini Track Biemission Module Non-polarized head

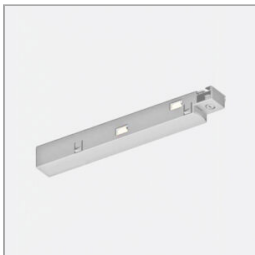

code LT9120/01

The Mini Track track is an electrified Class III-SELV track with two circuits: one for a low voltage 24/48V power supply and the other for the DATA BUS (DALI or 1-10V). The power supply voltage can be 24V or 48V, not exceeding 15°, depending on the models of lighting fixtures chosen. White and black finishes are available in the ceiling and suspended versions, while only the black finishing for the recessed option. The lighting fixtures can be used on both 24V or 48V electrified tracks, except the microfile family that requires only 24V. DALI dimmable spotlights are equipped with non-polarized converters that allow to be installed in any direction, and Hot Plug technology for safe insertion with live track.

Technical Sheet



Not polarized connector for track system

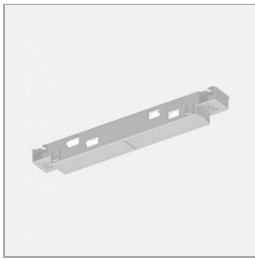

code LT9123/01

The Mini Track track is an electrified Class III-SELV track with two circuits: one for a low voltage 24/48V power supply and the other for the DATA BUS (DALI or 1-10V). The power supply voltage can be 24V or 48V, not exceeding 15°, depending on the models of lighting fixtures chosen. White and black finishes are available in the ceiling and suspended versions, while only the black finishing for the recessed option. The lighting fixtures can be used on both 24V or 48V electrified tracks, except the microfile family that requires only 24V. DALI dimmable spotlights are equipped with non-polarized converters that allow to be installed in any direction, and Hot Plug technology for safe insertion with live track.

Technical Sheet



Not polarized angle connector for track system



code LT9126/01

system indoor item. Bianco finishing item

Technical Sheet

