

**MINIFILE Recessed LED with diffuser**

code ML002.827

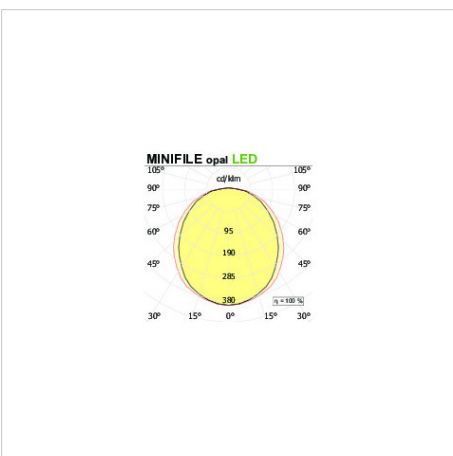
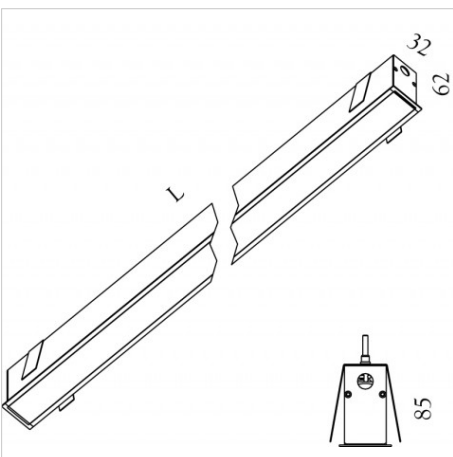

**PRODUCT DESCRIPTION**

Recessed with frame indoor direct emission lamp, complete of led 25,6W, color rendering index CRI >80, opal polycarbonate diffuser included. White/black/oxidised aluminium finishing direct emission lamp

**PRODUCT FEATURES**

Mounting method	recessed with frame
Lamps	linear LED
Wattage	25,6W
Color temperature	2700K
Color rendering index	>80
Finishing	white / black / oxidised aluminium
Source luminous flux	3968 lm
Diffuser	opal polycarbonate
Luminous flux	1442 lm
Fitting efficiency	56 lm/W
Chromaticity tolerance (initial 3 MacAdam)	
Estimated average life expectancy	50000h Ta 25° L70B10
Ballast	included
Protocol	On/Off
Mains voltage	220-240V / 50-60Hz
Energy efficiency class	A+
Dimension	L 1140 mm
Installation hole	mm 34xL+2
Class of protection	Class I appliance

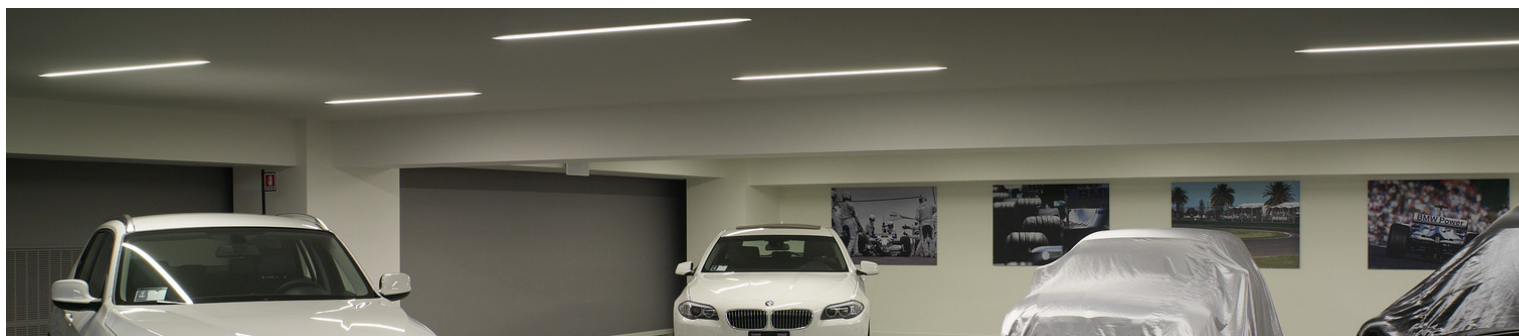

**ACCESSORIES**

---

LTMF.1000	wallbox Minifile
LTMF.2000	wallbox Minifile
LTMF.3000	wallbox Minifile
LTMF.misura	wallbox Minifile
LTM200.1	couple of closure heads for wallbox MINIFILE