

# lucifero's

MOD.218

REV. 21/09/2021

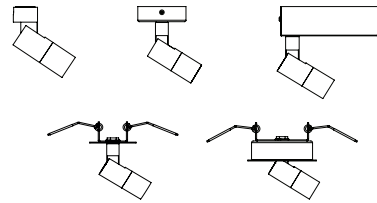

## FOCUS 26 36 55



**I** Il montaggio e la messa in funzione possono essere effettuati solo da tecnici autorizzati, nel rispetto delle presenti istruzioni di montaggio e di tutte le norme e disposizioni vigenti per il relativo campo di applicazione. Assicurarsi dell'idoneità elettrica, meccanica e termica della lampada per il campo di applicazione previsto e verificare dopo il montaggio che la lampada sia fissata saldamente. Prima di ogni sostituzione del corpo luminoso e prima di ogni intervento sulla lampada (ad esempio pulizia) staccare la tensione di rete e aspettare fino al completo raffreddamento della lampada e del corpo luminoso. Rispettare le istruzioni di montaggio del relativo produttore per l'impiego, la sostituzione e l'azionamento del corpo luminoso. Per la pulizia della lampada utilizzare un panno morbido e umido. Per la pulizia delle parti in plastica e dei riflettori si può utilizzare inoltre un detergente normale a pH neutro, senza alcool, non abrasivo. Conservare le presenti istruzioni di montaggio in buone condizioni per eventuali interventi di manutenzione. La lampada non deve essere in nessun caso coperta con coperture isolanti o materiali similari. I profili da incasso dovrebbero essere montati solo da personale specializzato (ai soffitti in cartongesso).

**UK** Installation and commissioning may only be performed by authorized and qualified personnel, taking into consideration this Installation Instructions and any standards and regulations applicable to the respective area of application. The electrical, mechanical and thermal suitability of the lamp for the intended area of application must be ensured and the secure fastening of the lamp after its installation must be controlled. Turn off supply voltage before replacing any illuminants as well as before performing any other works on the lamp (e.g. cleaning) and wait until lamp and illuminant have completely cooled off. Please refer to the installation notes of the illuminant manufacturer when inserting, replacing and operating illuminants. Use a soft, damp cloth to clean the lamp. To clean plastic components and reflectors, a standard pH neutral, alcohol-free, non-abrasive cleaning agent may also be used. Keep this Installation Instructions in a safe place as reference for any future maintenance works. Never cover the lamp with heat-insulating covers or similar materials. The recessed profiles should only be installed by instructed professionals (for plasterboard works).

**F** Le montage et la mise en fonctionnement ne peuvent être effectués que par des techniciens habilités, dans le respect des présentes instructions de montage et de toutes les normes et dispositions du secteur en vigueur. S'assurer de la compatibilité électrique, mécanique et thermique du luminaire pour le champ d'application prévu, et vérifier après le montage qu'il soit solidement fixé. Avant tout remplacement du corps éclairant et avant toute intervention sur le luminaire (par exemple le nettoyage), couper la tension de réseau et attendre le refroidissement complet du luminaire et du corps éclairant. Respecter les instructions de montage fournies par le producteur pour l'emploi, le remplacement et l'actionnement du corps éclairant. Pour le nettoyage du luminaire, utiliser un chiffon doux et humide. Pour le nettoyage des parties en matériel plastique et des réflecteurs, il est possible d'utiliser un détergent au pH neutre, sans alcool, non abrasif. Conserver soigneusement ces instructions de montage pour d'éventuelles interventions de maintenance. Le luminaire ne doit en aucun cas être recouvert d'une couverture isolante ou matériaux similaires. Les profils encastrés ne devraient être installés que par du personnel spécialisé (aux plafonds en placo-plâtre).

**D** Die Montage und die Inangangsetzung darf nur vom befugtem Fachpersonal durchgeführt werden, unter der Berücksichtigung der vorliegenden Montageanleitung, den ganzen Normen und den geltenden Anordnungen für den gegebenen Anwendungsbereich. Vergewissern Sie sich, dass die elektrischen, mechanischen und die thermische Eignung der Lampe für den vorgesehenen Anwendungsbereich richtig sind und überprüfen Sie, nach der Montage, die sichere Befestigung der Lampe. Schalten Sie, vor jedem Leuchtkörper Wechsel und vor allen sonstigen Arbeiten an der Lampe (z.B. Reinigung), die Netzspannung ab und warten Sie, dass die Lampe und der Leuchtkörper vollständig abgekühlt sind. Berücksichtigen Sie die Montageanleitung des Herstellers beim Einsetzen, Wechseln und der Bedienung des Leuchtkörpers. Verwenden Sie für die Reinigung der Lampe ein weiches, feuchtes Tuch. Für die Reinigung von Kunststoffteilen und Reflektoren können Sie zusätzlich ein handelsübliches Reinigungsmittel verwenden, mit neutralem pH-Wert, alkoholfrei und das nicht scheuert. Bewahren Sie diese Montageanleitung in gutem Zustand auf, für mögliche Reparaturarbeiten. Die Lampe darf unter keinen Umständen mit isolierenden Beschichtungen oder ähnlichem abgedeckt werden. Die Einbauprofile sollten nur von Fachkräften (in der Gipskartondecke) eingebaut werden.

**E** La instalación y la puesta en marcha solo debe realizarse por personal especializado teniendo en cuenta esta guía de instalación y todas las normas vigentes. Hay que asegurarse de la compatibilidad eléctrica, mecánica y térmica de la luminaria para la aplicación y comprobar la fijación segura de la luminaria tras su instalación. Antes de cambiar la lámpara o de realizar algún trabajo con ella (p. ej. Limpieza), siempre se debe apagar la corriente eléctrica. Hay que esperar hasta que la lámpara y la luminaria se enfríen completamente. Hay que tener en cuenta las instrucciones de montaje del fabricante en el momento de manipular la lámpara. Para la limpieza de la luminaria, se debe utilizar una tela suave y húmeda. Para limpiar componentes de plástico y reflectores, se puede usar un limpiador neutral sin alcohol para una limpieza no abrasiva. Guardar esta guía de instalación para trabajos de mantenimiento. Nunca se debe tapar la luminaria con recubrimientos aislantes o materiales similares. Los perfiles para empotrar deben ser instalados por personal especializado.



**I** Questo simbolo (cassonetto con ruote barrato, WEEE Allegato IV) indica la raccolta differenziata di apparecchiature elettriche ed elettroniche nei Paesi dell'UE. Non gettate l'apparecchio nei rifiuti domestici. Usate i sistemi di raccolta rifiuti disponibili nel vostro Paese.

**UK** This symbol [crossed-out wheeled bin WEEE Annex IV] indicates separate collection of waste electrical and electronic equipment in the EU countries. Please do not throw the equipment into the domestic refuse. Please use the return and collection systems available in your country for the disposal of this product.

**F** Le symbole [poubelle sur roue barrée d'une croix WEEE annexe IV] indique une collecte séparée des déchets d'équipements électriques et électroniques dans les pays de l'UE. Veuillez ne pas jeter l'équipement dans les ordures domestiques. A utiliser pour la mise en rebut de ces types d'équipements conformément aux systèmes de traitement et de collecte disponibles dans votre pays.

**D** Dieses Symbol [durchgestrichene Mülltonne nach WEEE Anhang IV] weist auf die getrennte Rücknahme elektrischer und elektronischer Geräte in EU-Ländern hin. Bitte werfen Sie das Gerät nicht in den Hausmüll. Informieren Sie sich über das in Ihrem Land gültige Rücknahmesystem und nutzen dieses zur Entsorgung.

**E** Este símbolo [un contenedor de basura tachado con una X en el Anexo IV de WEEE] indica que la recogida de basura de equipos eléctricos y electrónicos deberá tratarse por separado en los países de la Unión Europea. No tire este equipo a la basura doméstica. Para el desecho de este tipo de equipos utilice los sistemas de devolución al vendedor y de recogida que se encuentren disponibles.

Ci riserviamo la possibilità di apportare modifiche ai nostri prodotti in qualsiasi momento. I dati aggiornati sono disponibili all'indirizzo [www.luciferos.it](http://www.luciferos.it)  
We reserve the right to change our products at any time. Current information is available at [www.luciferos.it](http://www.luciferos.it)

En tous moments nous réservons le droit de modifier notre produits. Vous pouvez trouver la information actuelle toujours a [www.luciferos.it](http://www.luciferos.it)

Wir behalten uns vor, jederzeit Änderungen an unserm Produkten vorzunehmen. Aktuelle Daten stellen wir jederzeit unter [www.luciferos.it](http://www.luciferos.it) zur Verfügung.

Nos reservamos en todo momento el derecho de realizar cambios en nuestros productos. En nuestra pagina [www.luciferos.it](http://www.luciferos.it) siempre se encontrarán datos actuales.

**Lucifero's srl - via del Tappezziere, 3 - 40138 Bologna - Italia - ph. +39 051 6014276 - assistenza@luciferos.it - customercare@luciferos.it**

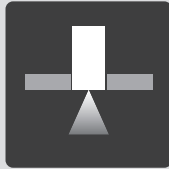

pag.4

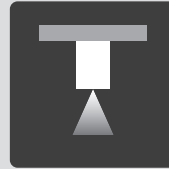

pag.8

## Focus Ø26

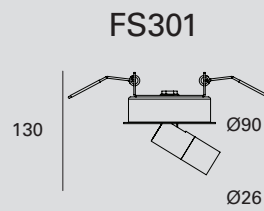
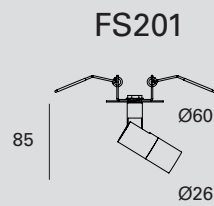
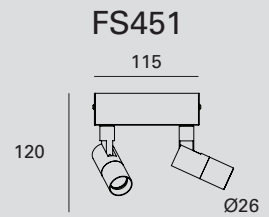
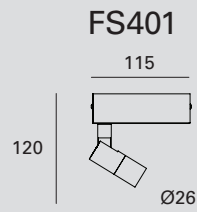
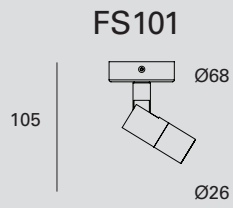
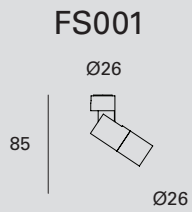

## Focus Ø36

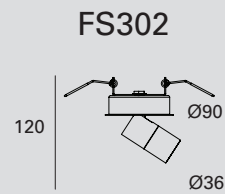
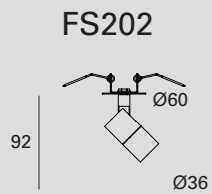
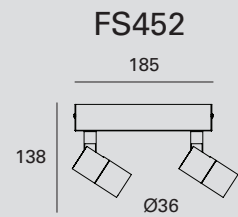
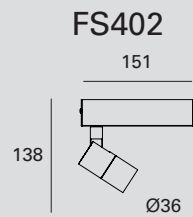
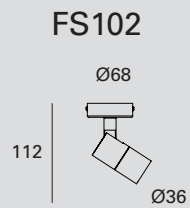
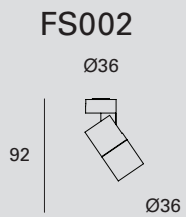

## Focus Ø55

FS003/005

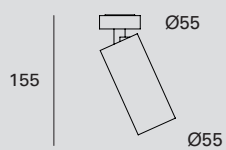

FS103/105

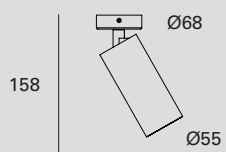

FS403/404

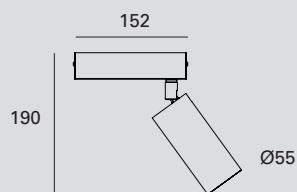

FS453/454

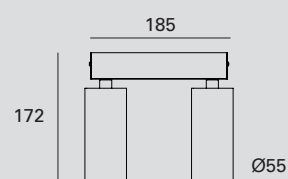

FS203/205

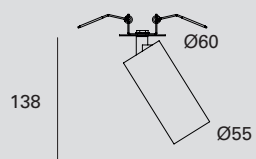

FS303/305

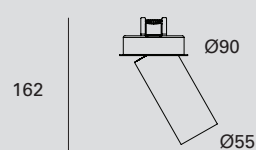

## Accessori

FSA01

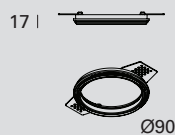

FSA02.26



FSA02.36



FSA02.55

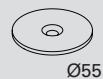

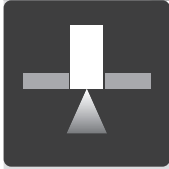

FS201

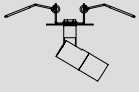

FS202

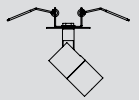

FS203/205

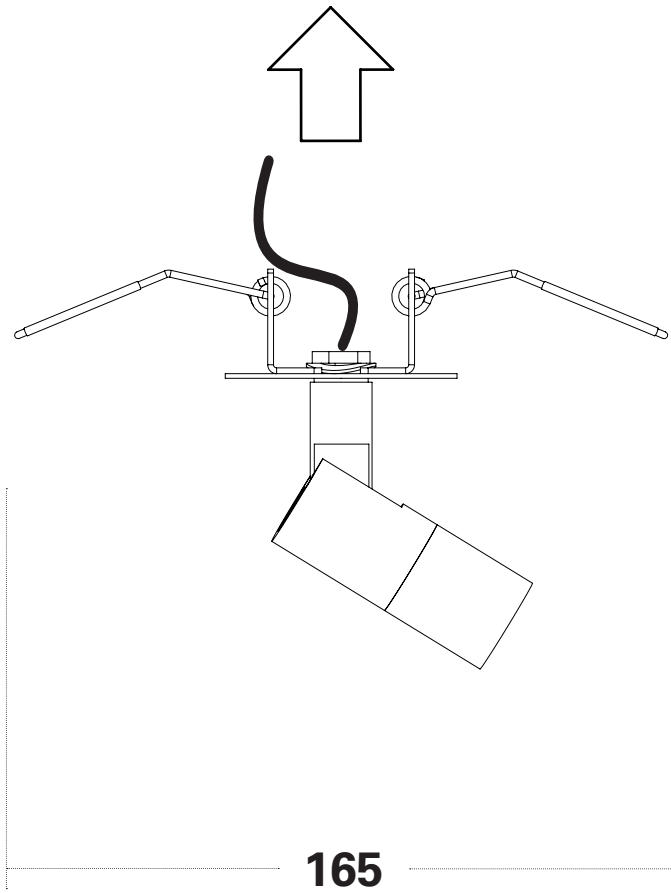
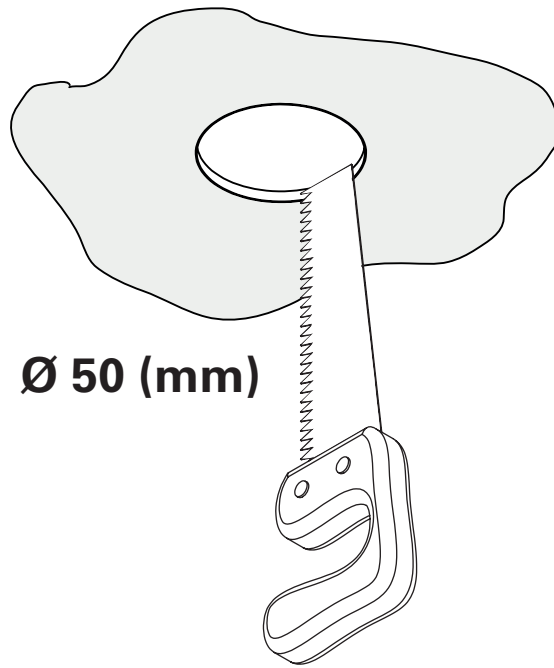
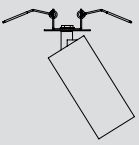

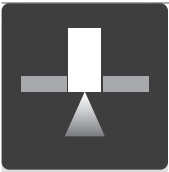

FS301

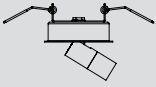

FS302

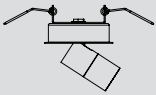

FS303/305

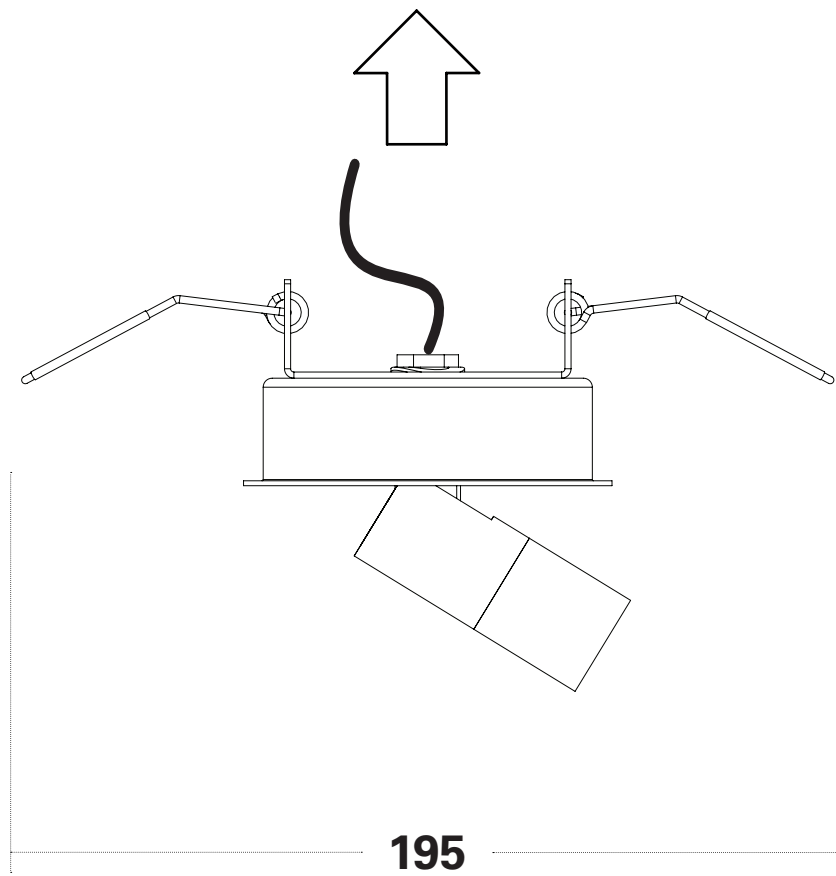
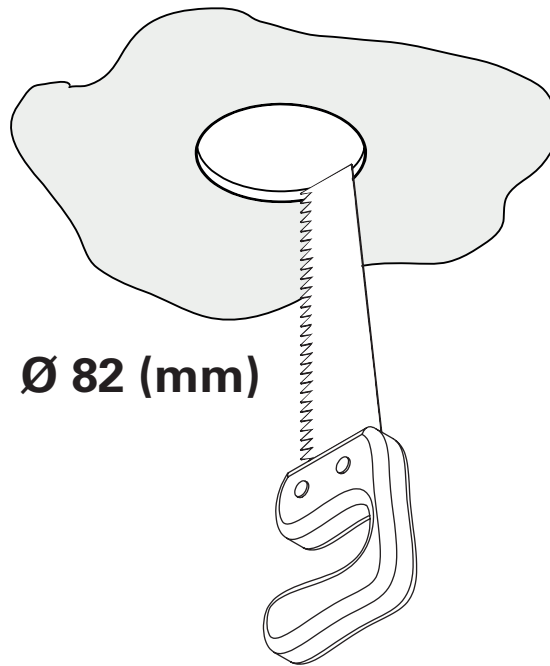
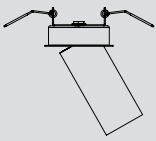

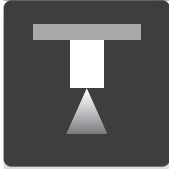

FS101

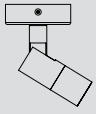

FS102

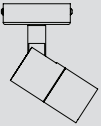

FS103/105

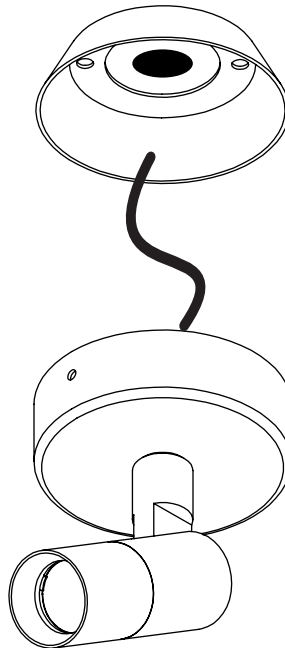
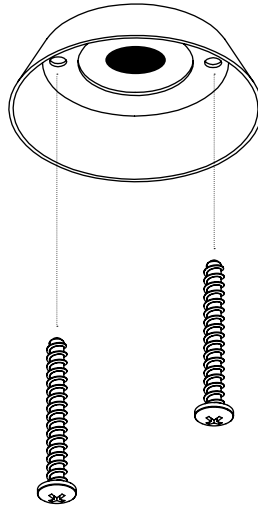
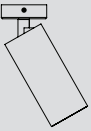

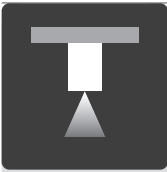

FS401

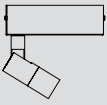

FS451

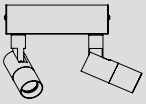

FS402

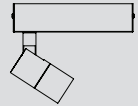

FS452

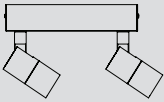

FS403/404

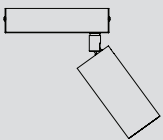

FS453/454

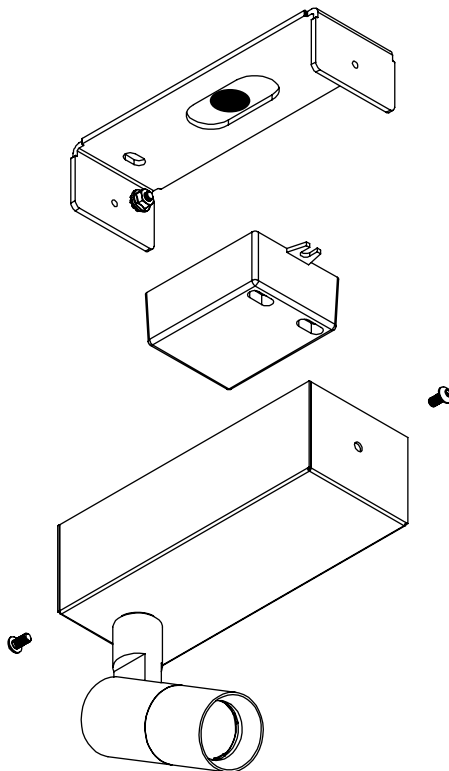
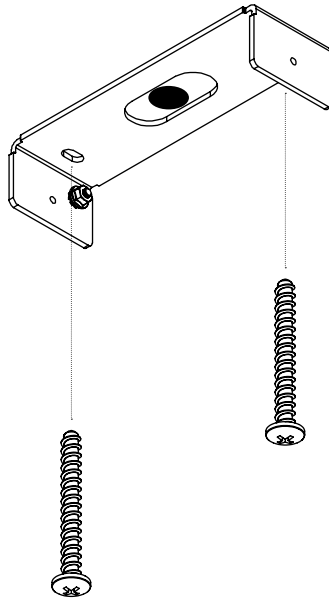
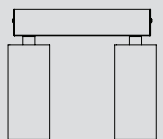

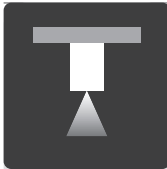

FS001



FS002



FS003/005

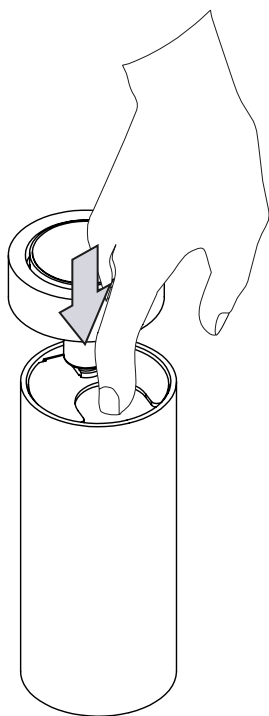
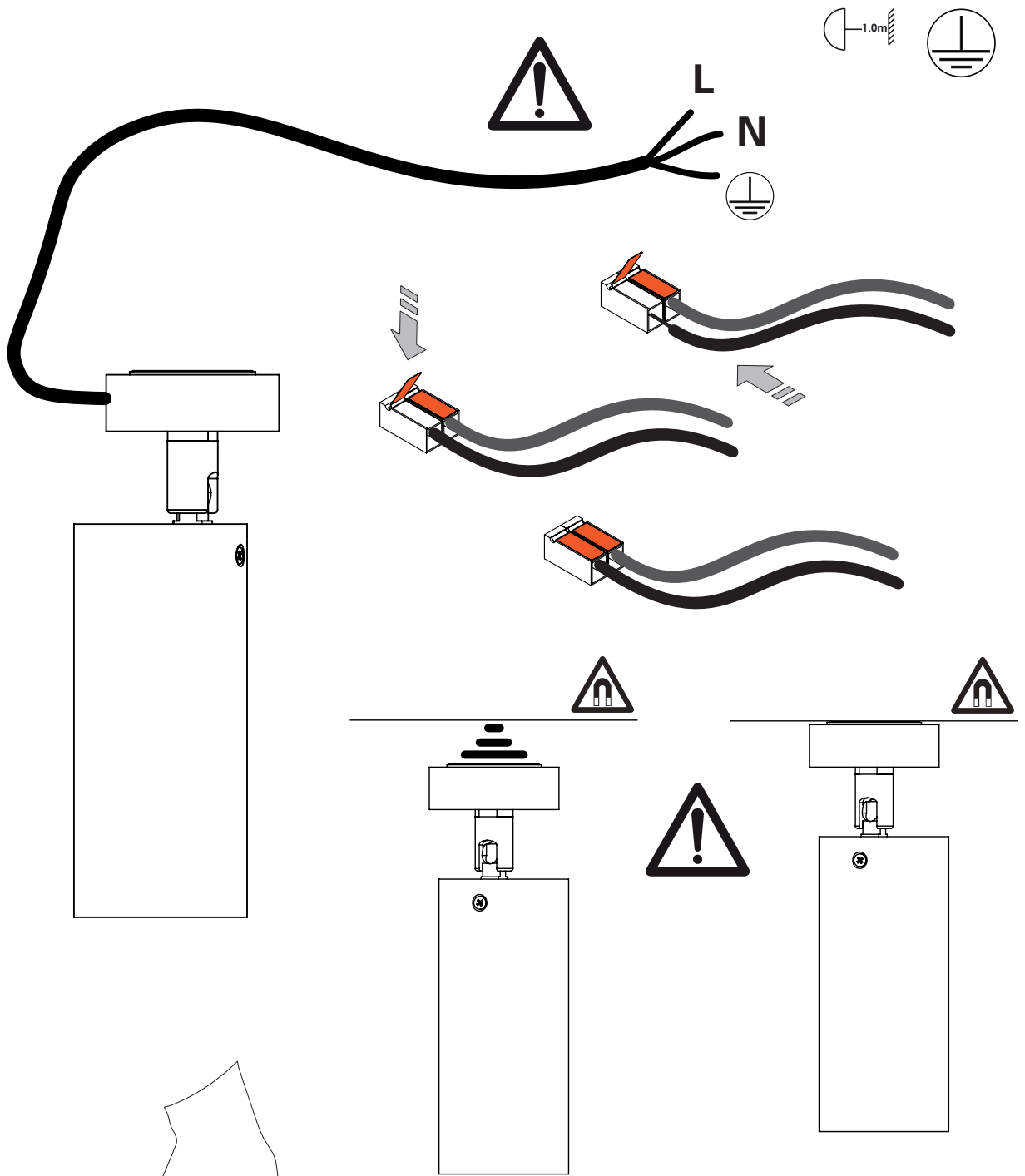
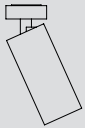

**REPLACE  
LAMP ONLY  
FOR GU10**

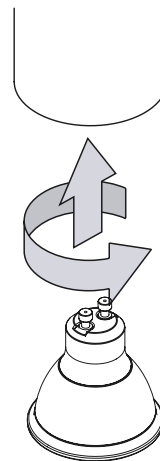

QPAR 16 230V





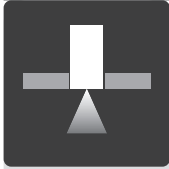

FSA01

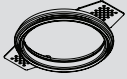

ONLY FOR Ø90

13 mm !!!

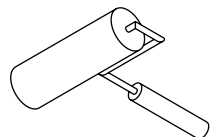
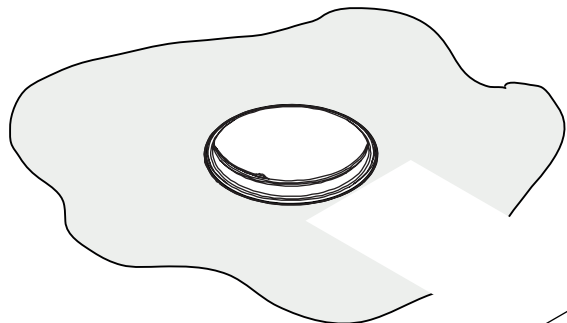
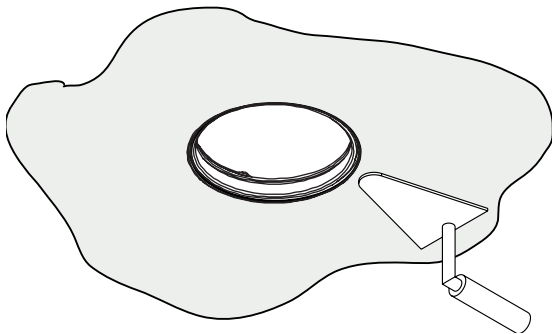
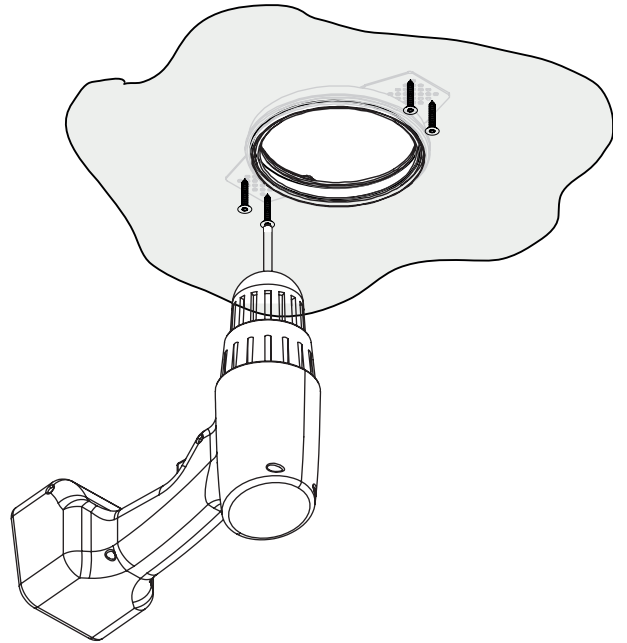
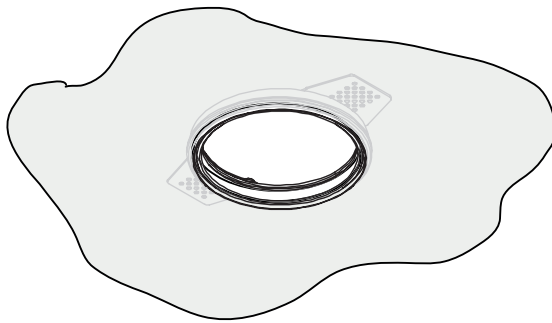
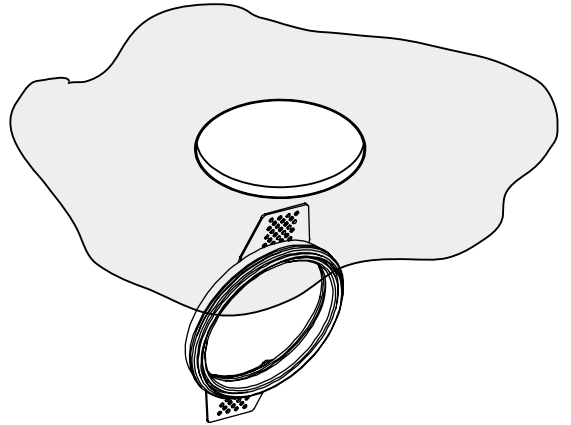
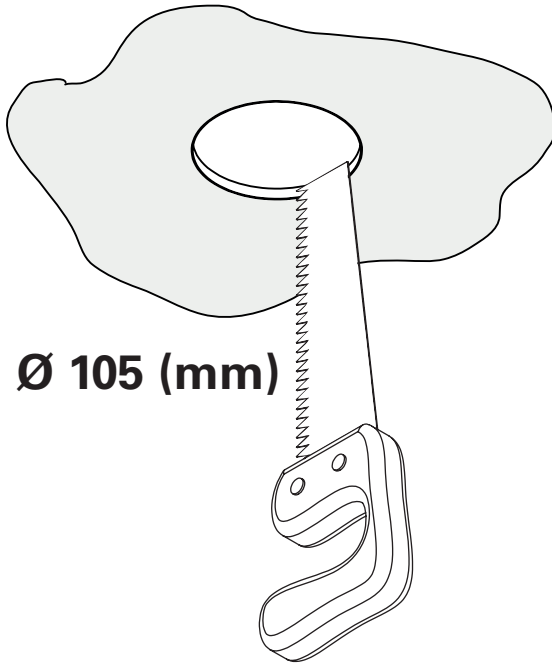
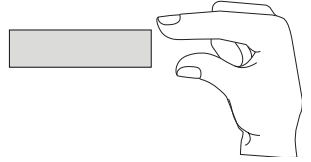

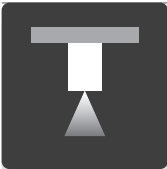

FSA02.26



FSA02.36



FSA02.55

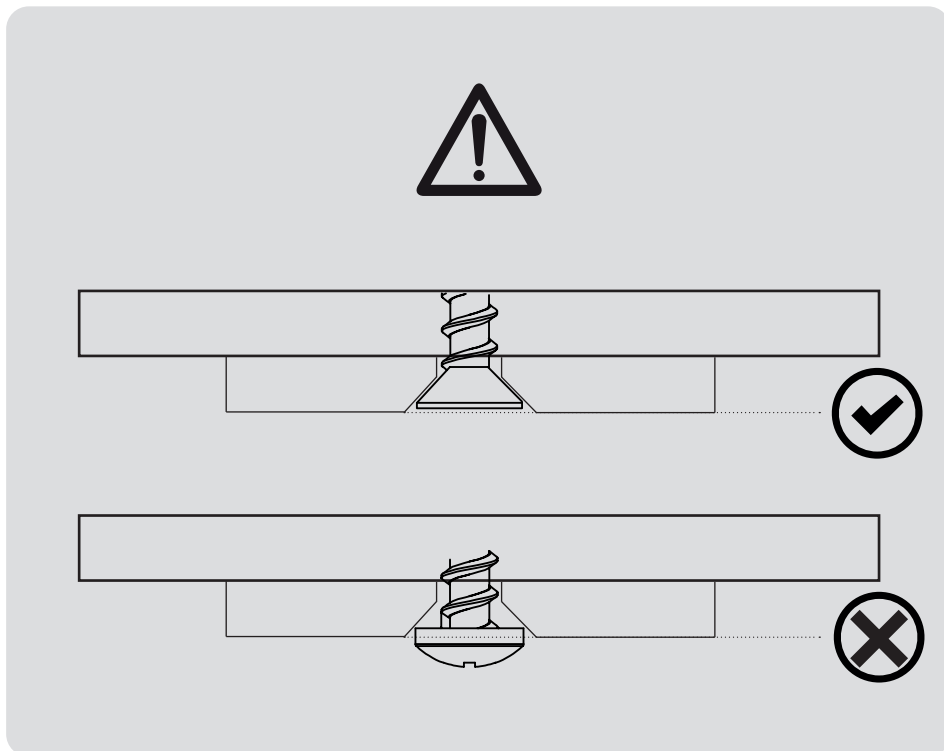
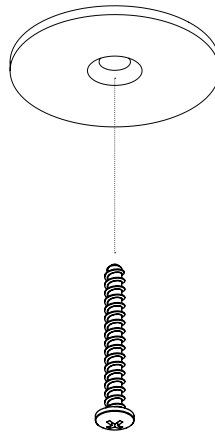











Istruzioni per il fine vita e lo smaltimento dei componenti  
 Instruction on end of life and component disposal  
 Istruccion pour la gestion des composant en fin de vie et leur mise au rebut  
 Anweisungen zur entsorgung der leuchtenkomponent  
 Instruccion para el final de vida y la eliminacion de los componentes

1

Interrompere l'alimentazione  
 Cut the power supply  
 Couper l'alimentation  
 Stromversorgung Unterbrechen  
 Interrumpir la alimentacion

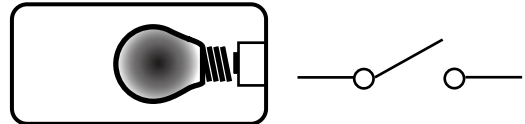

2

Rimuovere la/le lampade  
 Remove the lamps  
 Retirer les lampes  
 Entfernen Sie die Lampe/  
 Lampen  
 Retire las lámparas

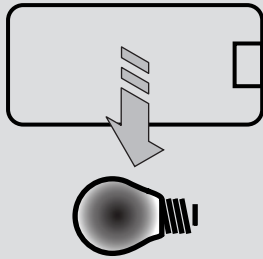

Rimuovere la batteria  
 Remove the battery  
 Retirez la batterie  
 Entfernen Sie die Batterie  
 Retire la batería

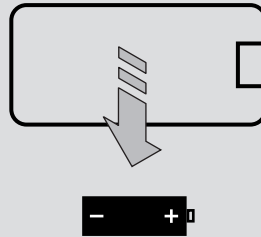

Rimuovere l'apparecchio  
 Remove the device  
 Retirez le périphérique  
 Entfernen Sie die Leuchte  
 Retire el dispositivo

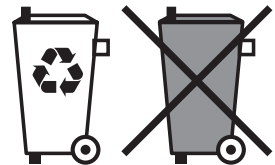
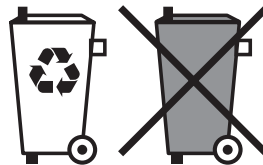
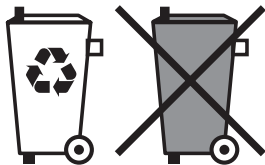
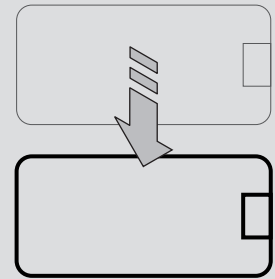

3

Inviare i materiali ad un centro di raccolta  
 Send the materials to a collection center  
 Envoyer le matériel à un centre de collecte  
 Bitte senden Sie die Materialien zu einer  
 ökologische Insel für Einsammeln  
 Enviar los materiales a un centro de  
 acopio

