



PRIVATE RESIDENCE – SYDNEY, AUSTRALIA
ARCHITECT: CORBEN ARCHITECTS
PHOTO: JASON ALEXANDER
LIGHTING PROJECT: PG GINEICO



MICROFILE

MICROFILE



WOOLWICH, SYDNEY AUSTRALIA
ARCHITECT/DESIGNER MICHIRU HIGGINBOTHAM
ARCHITECT IN ASSOCIATION ARC ARCHITECTS
PHOTO KATHERINE LU



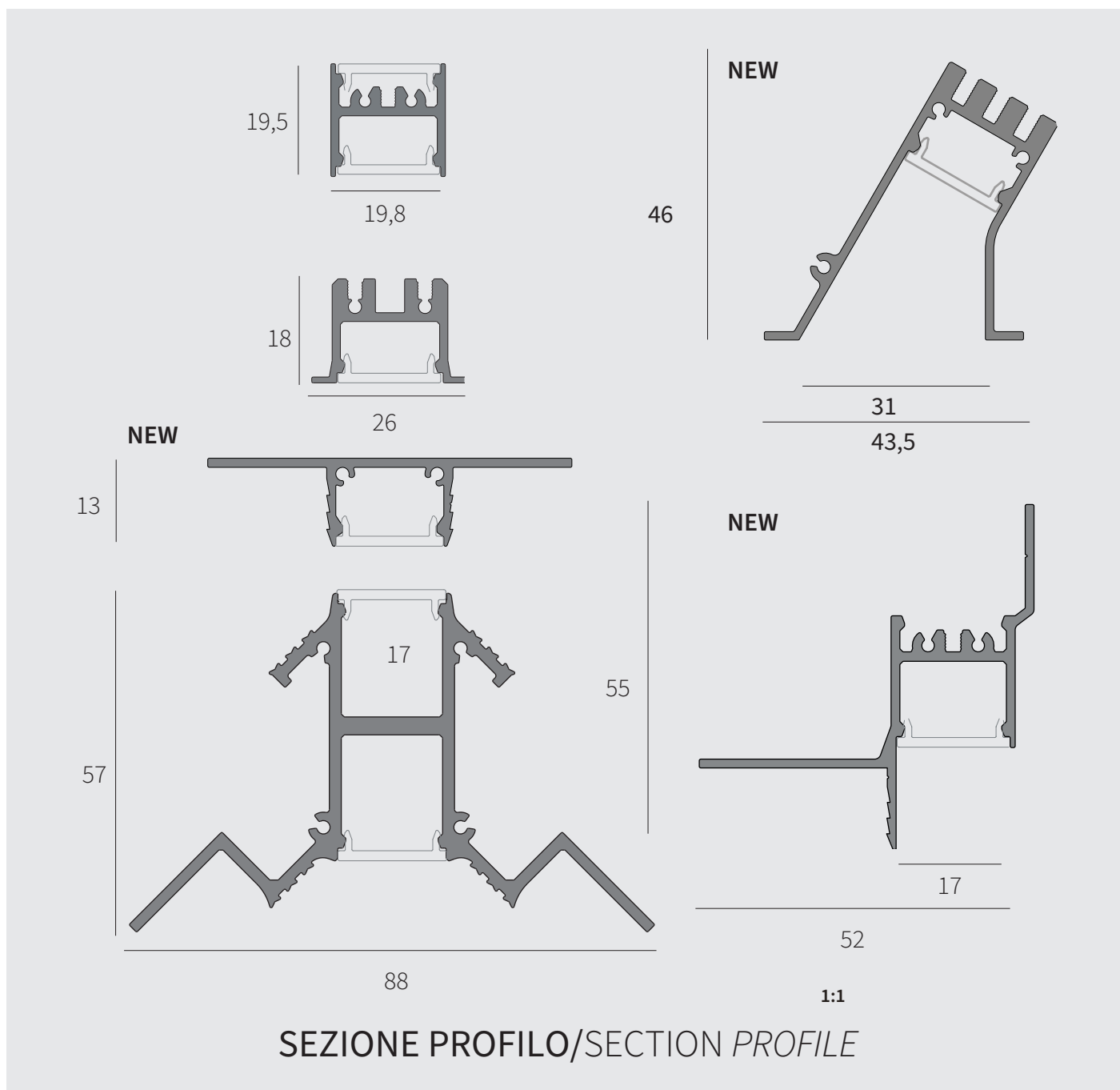

MICROFILE

Sistema modulare di profilo in estruso di alluminio 19,8x19,5mm, per installazione a sospensione e parete, soffitto, wallwasher, incasso rasato e incasso asimmetrico, sorgenti lineari led, da completare con alimentatori remoti 24Vdc. Finitura verniciata testurizzata. Schermi diffondenti in policarbonato opalino e testate di chiusura light-proof. Grado di protezione IP40.

Modular system of extruded aluminum profiles 19.8x19.5mm, for suspension, wall, ceiling installation, trimless recessed, wallwasher, asymmetric recessed, linear LED sources, to be completed with 24Vdc remote power supplies. Embossed painted finish. Opal polycarbonate diffusing screens and light-proof end heads. IP40.



UK CONFORMITY ASSESSMENT E EUROPEAN CERTIFICATION /
UK CONFORMITY ASSESSMENT AND EUROPEAN CERTIFICATION



PRODOTTI COSTRUITI CON MATERIALE RICICLABILE / PRODUCTS MADE OF
RECYCLABLE MATERIAL



GARANZIA DI 5 ANNI / 5-YEAR WARRANTY



DIFFUSORE SILICONE OPAL / OPAL SILICONE DIFFUSER



LINEA LED RGB - RGB WHITE / RGB - RGBW LINEAR LED

FINITURE/FINISHINGS



01 - BIANCO /
WHITE



02 - NERO /
BLACK

FINITURE PREMIUM /PREMIUM FINISHINGS



81-ORO ROSA/
ROSE GOLD



82-BRONZO/
BRONZE



83-OTTONE SATINATO /
BRUSHED BRASS

KELVIN



27 - 2700°K



30 - 3000°K



40 - 4000°K



DISPONIBILE SUL NOSTRO SITO IL CONFIGURATORE DI SISTEMI CON
METODO DRAG & DROP
Requisiti minimi richiesti schermo da 10 pollici

AVAILABLE ON OUR WEBSITE SYSTEM CONFIGURATOR WITH DRAG &
DROP METHOD
Minimum requirements required 10 inches screen

CURVE FOTOMETRICHE/PHOTOMETRIC DATA

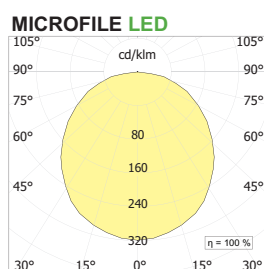

ASYMMETRIC

CEILING

TRIMLESS

WALL

CORNER

MICROFILE SISTEMA / SYSTEM



SUSPENSION

WALLWASHER

MICROFILE

MICROFILE

SISTEMA INCASSO



RECESSED SYSTEM

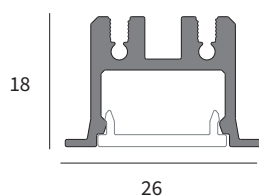

LOCATION B&B GASSA D'AMANTE, VIESTE
PROJECT DEL GIUDICE ARCHITETTURA
PHOTO MARCO REGGI





/## FINITURA PREMIUM /PREMIUM FINISHING

-  /81 oro rosa shine/shine rose gold
-  /82 bronzo/bronze
-  /83 ottone spazzolato/brushed brass

VERSIONI DISPONIBILI/AVAILABLE VERSION

/## FINITURA/FINISHING

-  /01 bianco | white
-  /02 nero | black

FINITURA CASSAFORMA /FINISHING WALLBOX

-  /27 alluminio anodizzato | anodized aluminium

COMPOSIZIONE CODICE: xxx.x /##

HOW TO CREATE THE CODE: **F1000/01**

CODE

F1000 /## — finishing

|

base code

.misura sostituire con la misura necessaria in mm. /
replace with the required measure in mm.

PROFILO VUOTO INCASSO / EMPTY CEILING PROFILE



Lmm	CODE
1000	MF02.1000/##
2000	MF02.2000/##
3000	MF02.3000/##
----	MF02.misura/##

Profilo completo di diffusore in policarbonato - Polycarbonate diffuser included.

COPPIA DI TESTATE DI CHIUSURA / COUPLE OF CLOSURE HEADS



CODE
MF00TI/##

MOLLA DI FISSAGGIO PROFILO / FIXING SPRING FOR RECESSED VERSION



CODE
MF02.SF

Molla singola per fissare il profilo lineare al controsoffitto. Una ogni metro, minimo 2 | Single spring for fixing the linear profile on the false-ceiling. One every meter, 2 pieces minimum.

DIFFUSORE IN SILICONE / SILICONE DIFFUSER



CODE
MFH00TH.misura

Lunghezza massima 20 m - Maximum length 20m

GIUNTO LINEARE / LINEAR JOINT



Lmm. CODE
2000 MF03.GL

ACCESSORI / ACCESSORIES

PER INSTALLAZIONE A LATERIZIO / CALCESTRUZZO FOR BRICK WALLS / CONCRETE

CASSAFORMA WALLBOX

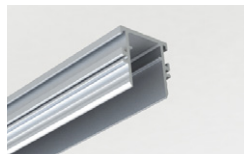
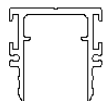

Dim.	H	L.mm	Kg	CODE
57	98	1000	0.55	MF08.1000 /27
57	98	2000	1.10	MF08.2000 /27
57	98	3000	1.65	MF08.3000 /27
57	98	-----	-----	MF08.misura/27

COPPIA DI TESTATE PER CASSAFORMA / COUPLE OF CLOSURE HEADS FOR WALLBOX



CODE
MF08T

KIT D'AGGANCIAMENTO MAGNETICO SINGOLO / MAGNETIC FIXING SINGLE KIT



CODE
MF08A

Per fissaggio modulo luminoso all'interno della cassaforma. ordinare 1 al m. (minimo 2 pezzi) | Single bracket to fix the lighting module within the wallbox, order 1 per m. (min. 2 pcs)



MICROFILE SISTEMA

INCASSO ASIMMETRICO TRIM **NEW**
ASYMMETRIC TRIM RECESSED

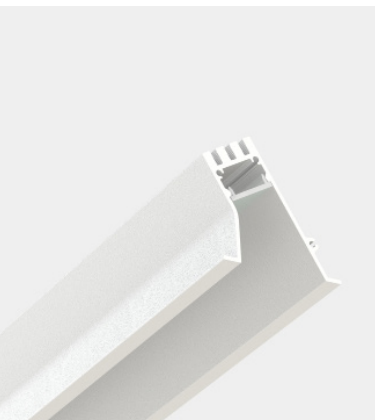

46

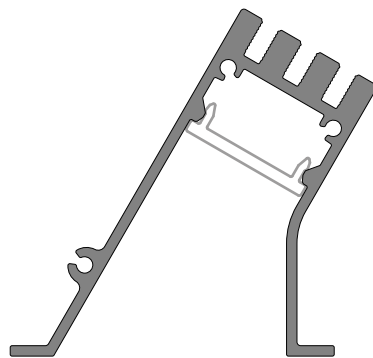

31

43,5

VERSIONI DISPONIBILI/AVAILABLE VERSION

FINITURA/FINISHING

/01 bianco | white

COMPOSIZIONE CODICE: xxx.x /##

HOW TO CREATE THE CODE: **F1000/01**

CODE

F1000 /01 — finishing /01 bianco | white

base code



.misura sostituire con la misura necessaria in mm. /
replace with the required measure in mm.

PROFILO VUOTO INCASSO ASIMMETRICO / ASYMMETRIC RECESSED EMPTY PROFILE
 completo di diffusore / included diffuser

spessore cartongesso / plasterboard thickness   



L.mm	Kg	CODE
1000	0.93	MF40.1000 /01
2000	1.86	MF40.2000 /01
3000	2.79	MF40.3000 /01
-----		MF40.misura /01

COPPIA DI TESTATE PER PROFILO INCASSO / COUPLE OF CLOSURE HEADS

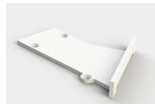

CODE
MF40TI

MOLLA DI FISSAGGIO PROFILO PER INCASSO / FIXING SPRING FOR RECESSED VERSION



CODE
MF40SF

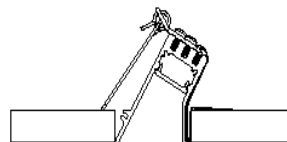

RICAMBIO DIFFUSORE IN POLICARBONATO OPALINO / SPARE OPAL WHITE POLYCARBONATE DIFFUSER



L.mm	Kg	CODE
1000	0.16	MF00P.1000
2000	0.33	MF00P.2000
3000	0.50	MF00P.3000
-----		MF00P.misura



ELEMENTI LUMINOSI /LIGHT ELEMENTS P. 138

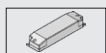

DRIVERS VEDI | SEE P. 447

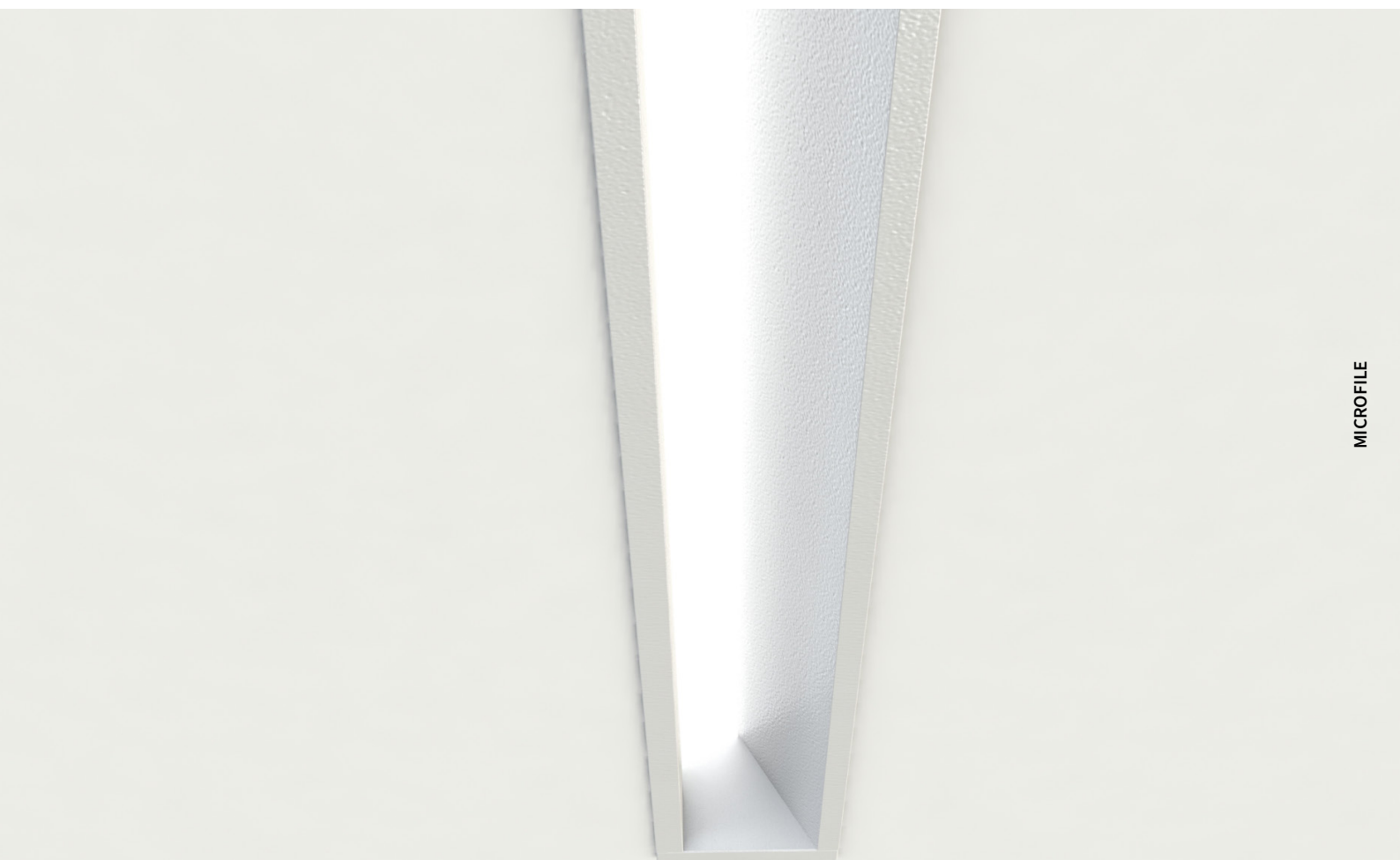

MICROFILE

SISTEMA INCASSO RASATO

TRIMLESS RECESSED SYSTEM

7EVEN TOWER REGGIO EMILIA
TTM SPA

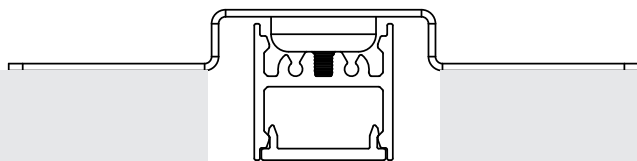

19,8

VERSIONI DISPONIBILI/AVAILABLE VERSION

/## FINITURA/FINISHING



/01 bianco | white



/02 nero | black

COMPOSIZIONE CODICE: xxx.x /##

HOW TO CREATE THE CODE: F1000/01

CODE

F1000 /## — finishing

|
base code

.misura sostituire con la misura necessaria in mm. /
replace with the required measure in mm.

PROFILO VUOTO INCASSO RASATO / TRIMLESS RECESSED EMPTY PROFILE

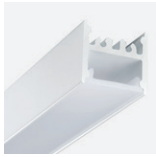

Lmm	CODE
1000	MF01.1000/##
2000	MF01.2000/##
3000	MF01.3000/##
----	MF01.misura/##

Profilo completo di diffusore in policarbonato - Polycarbonate diffuser included.

COPPIA DI TESTATE DI CHIUSURA / COUPLE OF CLOSURE HEADS



CODE
MF00TP/##

STAFFE DI FISSAGGIO / FIXING BRACKET



CODE
MF05.M

Staffa singola per fissare il profilo lineare al controsoffitto. Una ogni metro, minimo 2 | Single bracket for fixing the linear profile on the false-ceiling. One every meter, 2 pieces minimum.

DIFFUSORE IN SILICONE / SILICONE DIFFUSER



CODE
MFH00TH.misura/##

Lunghezza massima 20 m - Maximum length 20m

GIUNTO LINEARE / LINEAR JOINT



Lmm. CODE
2000 MF03.GL



ELEMENTI LUMINOSI / LIGHT ELEMENTS P. 138



DRIVERS VEDI | SEE P. 447

MICROFILE

SISTEMA INCASSO SUPERSLIM ^{NEW}

SUPERSLIM RECESSED SYSTEM



Location: appartamento privato - Genova, Italia
Project: Ministudio Architetti
Photo: Bruno Ravera

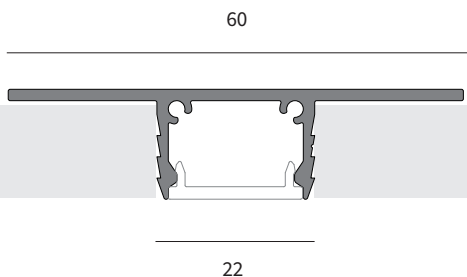

VERSIONI DISPONIBILI/AVAILABLE VERSION

COMPOSIZIONE CODICE: xxx/##

HOW TO CREATE THE CODE: **F1000/01**

CODE

F1000 /27 — finishing alluminio | aluminium

|
base code

.misura sostituire con la misura necessaria in mm. /
replace with the required measure in mm.

PROFILO VUOTO INCASSO RASATO SUPERSLIM H13 / TRIMLESS RECESSED EMPTY PROFILE H13 SUPERSLIM

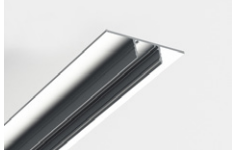

Lmm	Kg	CODE
1000	0.95	MF42.1000/27
2000	2.00	MF42.2000/27
3000	2.60	MF42.3000/27
-----		MF42.misura/27

Profilo completo di doppio diffusore: il primo viene utilizzato come protezione del profilo stesso durante l'installazione e poi rimosso, il secondo come diffusore definitivo. |

COPPIA DI TESTATE PER PROFILO INCASSO RASATO / COUPLE OF CLOSURE HEADS FOR TRIMLESS RECESSED PROFILE

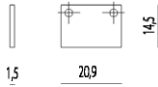

CODE
MF42TI

DIFFUSORE IN POLICARBONATO OPALINO / OPAL WHITE POLYCARBONATE DIFFUSER



Lmm	Kg	CODE
1000	0.16	MF00P.1000
2000	0.33	MF00P.2000
3000	0.50	MF00P.3000
-----		MF00P.misura

DIFFUSORE IN SILICONE / SILICONE DIFFUSER



CODE
MFH00TH.misura

Lunghezza massima 20 m - Maximum length 20m



ELEMENTI LUMINOSI / LIGHT ELEMENTS P. 138

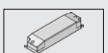

DRIVERS VEDI | SEE P. 447

MICROFILE SISTEMA

INCASSO ARRETRATO RADENTE NEW *WALL WASHER BACK RECESSED*

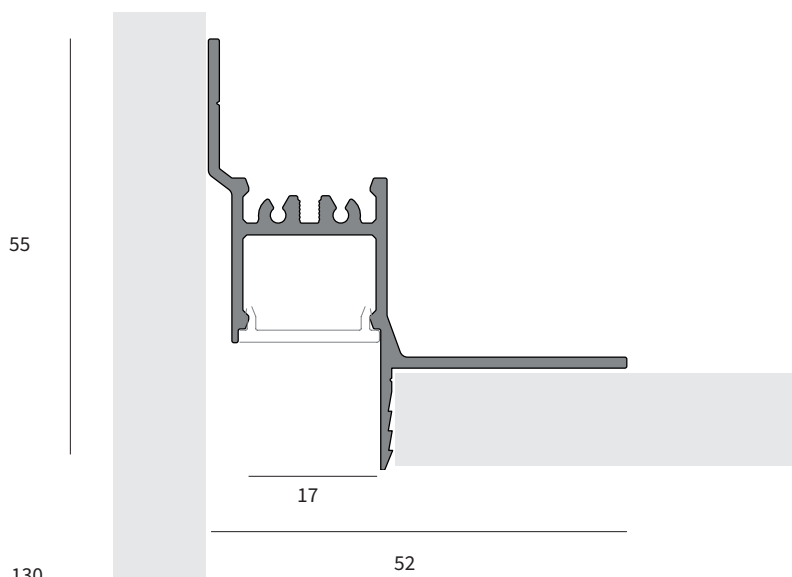

VERSIONI DISPONIBILI/AVAILABLE VERSION

COMPOSIZIONE CODICE: xxx /##

HOW TO CREATE THE CODE: **F1000/01**

CODE

F1000 /27 — finishing  alluminio | aluminium

|
base code

.misura sostituire con la misura necessaria in mm. /
replace with the required measure in mm.

PROFILO VUOTO INCASSO RASATO / TRIMLESS RECESSED EMPTY PROFILE

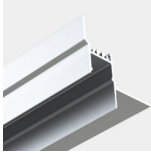

Lmm	Kg	CODE
1000	0.95	MF41.1000/27
2000	2.00	MF41.2000/27
3000	2.60	MF41.3000/27
-----		MF41.misura/27

COPPIA DI TESTATE PER PROFILO INCASSO RASATO / COUPLE OF CLOSURE HEADS FOR TRIMLESS RECESSED PROFILE



CODE
MF41TI

DIFFUSORE IN POLICARBONATO OPALINO / OPAL WHITE POLYCARBONATE DIFFUSER

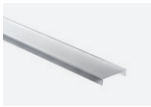

L.mm	Kg	CODE
1000	0.16	MF00P.1000
2000	0.33	MF00P.2000
3000	0.50	MF00P.3000
-----		MF00P.misura

DIFFUSORE IN SILICONE / SILICONE DIFFUSER



CODE
MFH00TH.misura

Lunghezza massima 20 m - Maximum length 20m



ELEMENTI LUMINOSI / LIGHT ELEMENTS P. 138

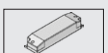

DRIVERS VEDI | SEE P. 447

MICROFILE

SISTEMA SOFFITTO

CEILING SYSTEM



TUTTOLINGUE CATANIA
ARCH. DARIO ANTIGNANO

19,5

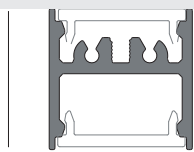

19,8

VERSIONI DISPONIBILI/AVAILABLE VERSION

/ ## FINITURA/FINISHING



/01 bianco | white

/02 nero | black

/ ## FINITURA PREMIUM /PREMIUM FINISHING

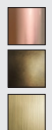

/81 oro rosa shine/shine rose gold

/82 bronzo/ bronze

/83 ottone spazzolato/ brushed brass

COMPOSIZIONE CODICE: xxx.x /##

HOW TO CREATE THE CODE: **F1000/01**

CODE

F1000 /## — finishing

|
base code

.misura sostituire con la misura necessaria in mm. /
replace with the required measure in mm.

PROFILO VUOTO / EMPTY PROFILE



Lmm	CODE
1000	MF01.1000/##
2000	MF01.2000/##
3000	MF01.3000/##
----	MF01.misura/##

Profilo completo di diffusore in policarbonato - Polycarbonate diffuser included.

COPPIA DI TESTATE DI CHIUSURA / COUPLE OF CLOSURE HEADS



CODE
MF00TP/##

SISTEMA D'AGGANCIO / FIXING SYSTEM



Lmm	CODE
1000	MF00DP.1000
2000	MF00DP.2000
3000	MF00DP.3000

DIFFUSORE IN POLICARBONATO OPALINO / OPAL WHITE POLYCARBONATE DIFFUSER



L.mm	Kg	CODE
1000	0.16	MF00P.1000
2000	0.33	MF00P.2000
3000	0.50	MF00P.3000
-----		MF00P.misura

DIFFUSORE IN SILICONE / SILICONE DIFFUSER



CODE
MFH00TH.misura

Lunghezza massima 20 m - Maximum length 20m

GIUNTO LINEARE / LINEAR JOINT



Lmm.	CODE
2000	MF03.GL



ELEMENTI LUMINOSI / LIGHT ELEMENTS P. 138

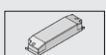

DRIVERS VEDI | SEE P. 447

MICROFILE

SISTEMA SOSPENSIONE

SUSPENSION SYSTEM

IZAKAYA JAPANESE RESURANT SYDNEY
PROJECT MICHIRU DESIGN STUDIO

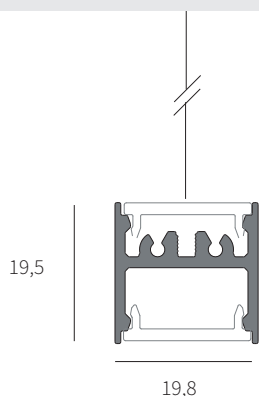

VERSIONI DISPONIBILI/AVAILABLE VERSION

/ ## FINITURA/FINISHING



/01 bianco | white



/02 nero | black

/ ## FINITURA PREMIUM /PREMIUM FINISHING



/81 oro rosa shine/shine rose gold



/82 bronzo/ bronze



/83 ottone spazzolato/ brushed brass

COMPOSIZIONE CODICE: xxx.x /##

HOW TO CREATE THE CODE: F1000/01

CODE

F1000 /## — finishing

|
base code

.misura sostituire con la misura necessaria in mm. /
replace with the required measure in mm.

PROFILO VUOTO / EMPTY PROFILE



Lmm	CODE
1000	MF01.1000 / ##
2000	MF01.2000/ ##
3000	MF01.3000/ ##
----	MF01.misura/ ##

Profilo completo di diffusore in policarbonato - Polycarbonate diffuser included.

COPPIA DI TESTATE DI CHIUSURA / COUPLE OF CLOSURE HEADS



CODE
MF00TP/##

MOLLA SINGOLA PER CARTONGESSO / SINGLE SPING FOR FALSE CEILING



CODE
MF02.SF

Molla singola per fissare il profilo lineare al controsoffitto. Una ogni metro, minimo 2 | Single spring for fixing the linear profile on the false-ceiling. One every meter, 2 pieces minimum.

DIFFUSORE IN SILICONE / SILICONE DIFFUSER



CODE
MFH00TH.misura/##

Lunghezza massima 20 m - Maximum lenght 20m

KIT ALIMENTAZIONE SOSPENSIONE CON ROSONE E DRIVER INCLUSI POWER CABLE KIT WITH CEILING CANOPY AND DRIVER INCLUDED



W	Dim.	H	CODE
30	355x32x40	2000	MFH00SA/01
60	355x32x40	2000	MFH00SB/01



KIT ALIMENTAZIONE SOSPENSIONE CON ROSONE / POWER CABLE KIT WITH CEILING CANOPY



Dim.	H	CODE
62x40x45	2000	MFH01S/##

CAVO SINGOLO DI SOSP. IN ACCIAIO L.2000mm / STEEL SUSPENSION KIT L. 2000 mm



Lmm.	CODE
2000	MF03.SO/##

GIUNTO LINEARE / LINEAR JOINT



CODE
MF03.GL



ELEMENTI LUMINOSI /LIGHT ELEMENTS P. 138

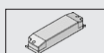

DRIVERS VEDI | SEE P. 447

MICROFILE

SISTEMA ANGOLARE

CORNER SYSTEM

INSTALLAZIONE IN ANGOLO ESTERNO
RECESSED WITHIN AN OUTSIDE CORNER

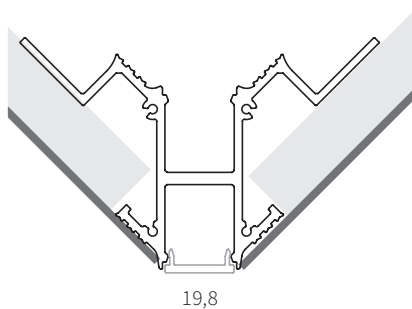

INSTALLAZIONE IN ANGOLO INTERNO
RECESSED WITHIN AN INSIDE CORNER

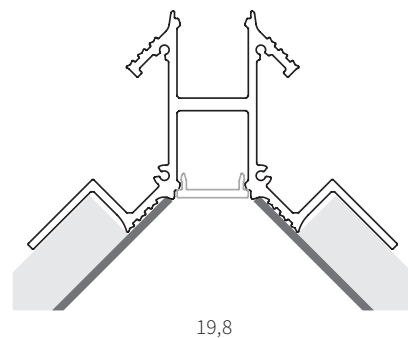

Un solo profilo due possibilità di installazione
One profile two installation options



Lmm	CODE
1000	MF04.1000/##
2000	MF04.2000/##
3000	MF04.3000/##
-----	MF04.misura/##

Profilo compreso di diffusore - Diffuser included

COPPIA TESTATE ANGOLARE / COUPLE OF CLOSURE HEADS, CORNER VERSION



CODE
MF00TA/##

GIUNTO LINEARE / LINEAR JOINT



Lmm.	CODE
2000	MF03.GL



DIFFUSORE IN POLICARBONATO OPALINO / OPAL WHITE POLYCARBONATE DIFFUSER





L.mm	Kg	CODE
1000	0.16	MF00P.1000
2000	0.33	MF00P.2000
3000	0.50	MF00P.3000
-----		MF00P.misura

VERSIONI DISPONIBILI/AVAILABLE VERSION

/ ## FINITURA/FINISHING

-  /01 bianco | white
-  /02 nero | black

/ ## FINITURA PREMIUM /PREMIUM FINISHING

-  /81 oro rosa shine/shine rose gold
-  /82 bronzo/ bronze
-  /83 ottone spazzolato/ brushed brass

COMPOSIZIONE CODICE: xxx.x /##

HOW TO CREATE THE CODE: **F1000/01**

CODE

F1000 /## — finishing

|
base code

.misura sostituire con la misura necessaria in mm. /
replace with the required measure in mm.



ELEMENTI LUMINOSI /LIGHT ELEMENTS P. 138

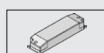

DRIVERS VEDI | SEE P. 447

MICROFILE

ELEMENTI LUMINOSI

LIGHT ELEMENTS

LINEA DI LUCE DA 5 METRI/ LED LINE 5 METERS ROLL

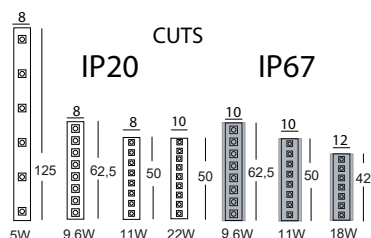

Strip led ad alta efficienza con biadesivo e supporto di larghezza 8-12 mm su bobina da 5 metri, da alimentare con driver stabilizzati in tensione da 24Vdc. Classe di isolamento III. | High efficiency strip led with biadhesive and support of 8-12 mm wide on 5 meters roll. To be fed with 24Vdc voltage-stabilized driver. Insulation class III.

Linea di luce Led IP20 24V

W/m	V	Led/m	lm/m	lm/W	CRI	IP	Lmm	CODE
5,5	24	60	270	49	80	20	5000	ST05.O.5
9,6	24	120	540	56	80	20	5000	ST10.O.5
11	24	180	1200	109	80	20	5000	ST11.O.5
22	24	168	3015	139	80	20	5000	ST22.O.5
13+13	24	80+80	2120+2230	2700-6500K	cut 50mm	20	5000	ST22.TW.5

Linea di luce Led IP67 24V

W/m	V	Led/m	lm/m	lm/W	CRI	IP	Lmm	CODE
9,6	24	120	540	56	80	67	5000	ST10.O.5IP
11	24	160	1660	151	80	67	5000	ST15.O.5IP
18	24	168	1964	109	80	67	5000	ST20.O.5IP

Linea di luce RGB- RGBW 24V

W/m	V	Led/m	lm/m	Beam	Type	CUT	Lmm	CODE
95W	24	60	270	120°	RGB + White 3000K	100	5000	ST20.RGBW.5
100W	24	120	540		RGB + White 2700K	100	5000	ST19.RGBW.5IP
100W	24	168	3015		RGB + White 2700K	100	5000	ST19.RGBW.5



VERSIONI DISPONIBILI/AVAILABLE VERSION

- KELVIN
- 27 2700K
- 30 3000K
- 40 4000K

COMPOSIZIONE CODICE: xxx.x ○ /##

HOW TO CREATE THE CODE: **F1000.827/01**

CODE

F1000.8 ○ /## — finishing

| |
base code kelvin



B&B GASSA D'AMANTE VIESTE
PHOTO MARCO REGGI

MICROFILE